

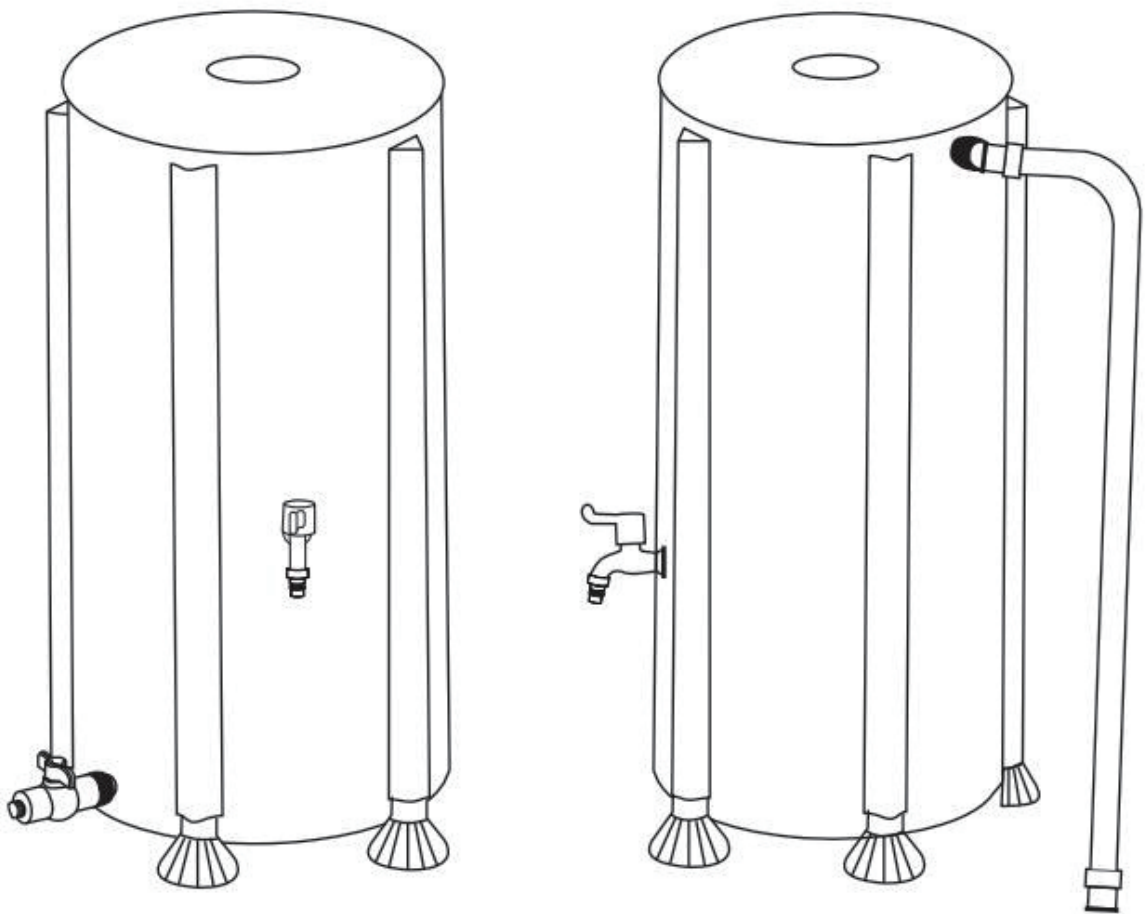

COLLAPSIBLE RAIN BARREL
750L/1000L
JRS750_JRS1000



Note: Please read this manual before using!

Product Introduction

The product is used for collecting rainwater, which is connected with down-comer from the wall of house to store rainwater. It can be widely used in garden irrigation, car washing, dirt cleaning and other related usage with characteristics of energy saving, environmental protection, easy to use and so on; It can be used from minus 35 degrees to 80 degrees because of adopting long-lived waterproof PVC synthetic materials. Therefore it saves the cost of Usage and maintenance for user, and the design of easy collapse provides the user great convenience of usage and storage.

Please read the instructions before using the product, It will tell you the methods of correct operation and Installation.

Packing List

NO.	Part Name	Unit	Quantity	Remark
1	Water Bag	set	1	
2	Overflow Part	set	1	
3	Outlet Valve	set	1	
4	Supporting Rod	set	6	
5	1m Hose	set	1	
6	Water Tap	set	1	

The pictures of accessories

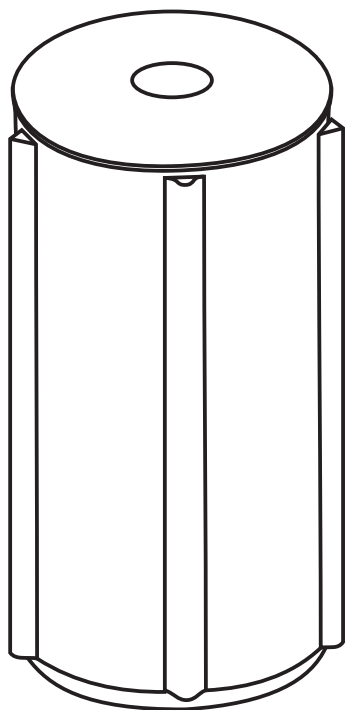

Water tank

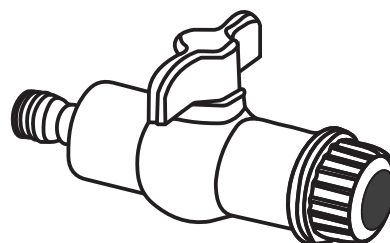

Outlet accessories



Supporting bar accessories

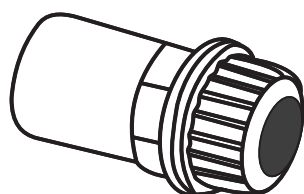

Overflow accessories

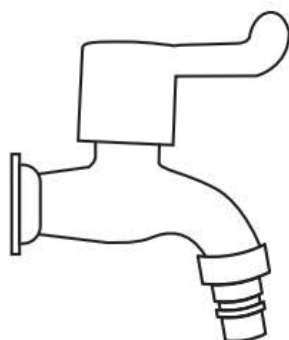

Water Tap

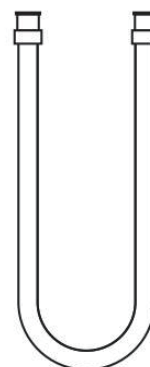

1m Hose

Fitting instruction

1. Firstly, take the water bag out of the Package box, unfold it Then take out the outlet accessories, screw out the obturating ring and the fixed screw cap from the tap of the outlet accessories (picture 1), put the main part of the outlet accessories through the installing hole of water bag. Then screw up with the fixed screw cap and obturating ring from the inner side of water bag You can check picture 2 for the details which is the sequence of installed outlet accessories

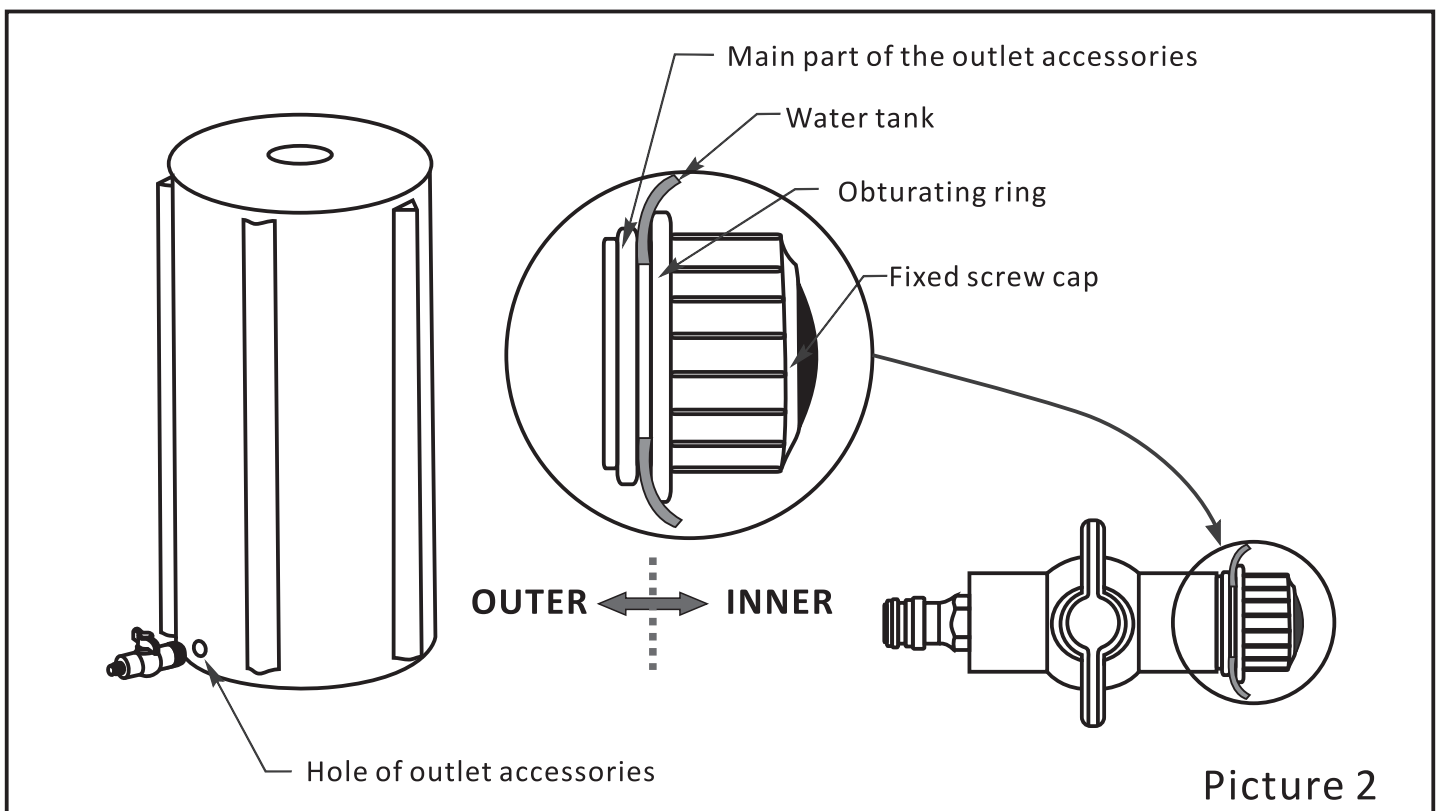
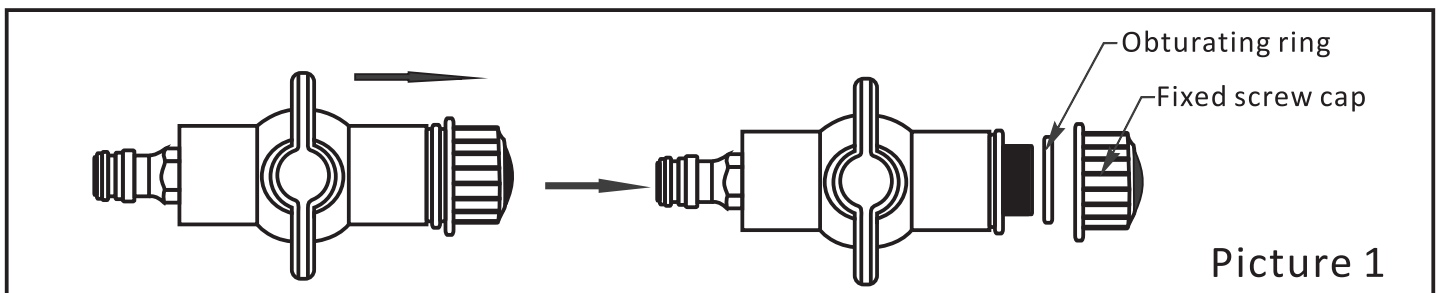

Fitting instruction

2. Secondly, take out the overflow accessories from the packing box, then screw out the fixed screw cap from the tap of the overflow accessories (picture 3), put the main part of the overflow accessories through the installing hole of water bag, then screw up them with the fixed screw cap from the inner side of water bag, You can check picture 4 for the details which is the sequence of installed overflow accessories.

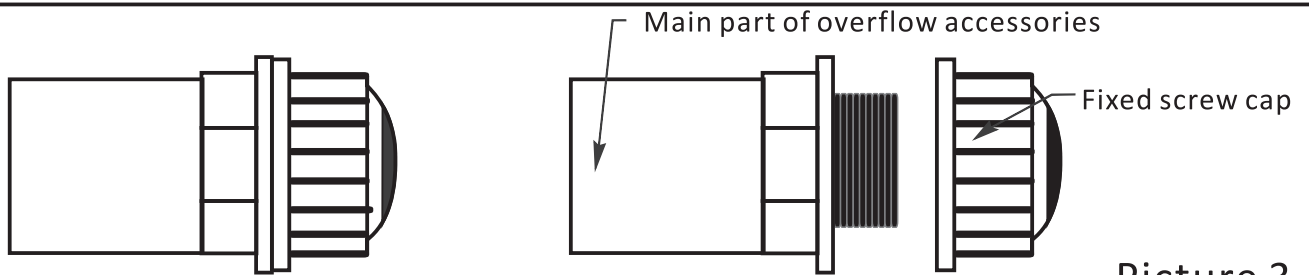

Picture 3

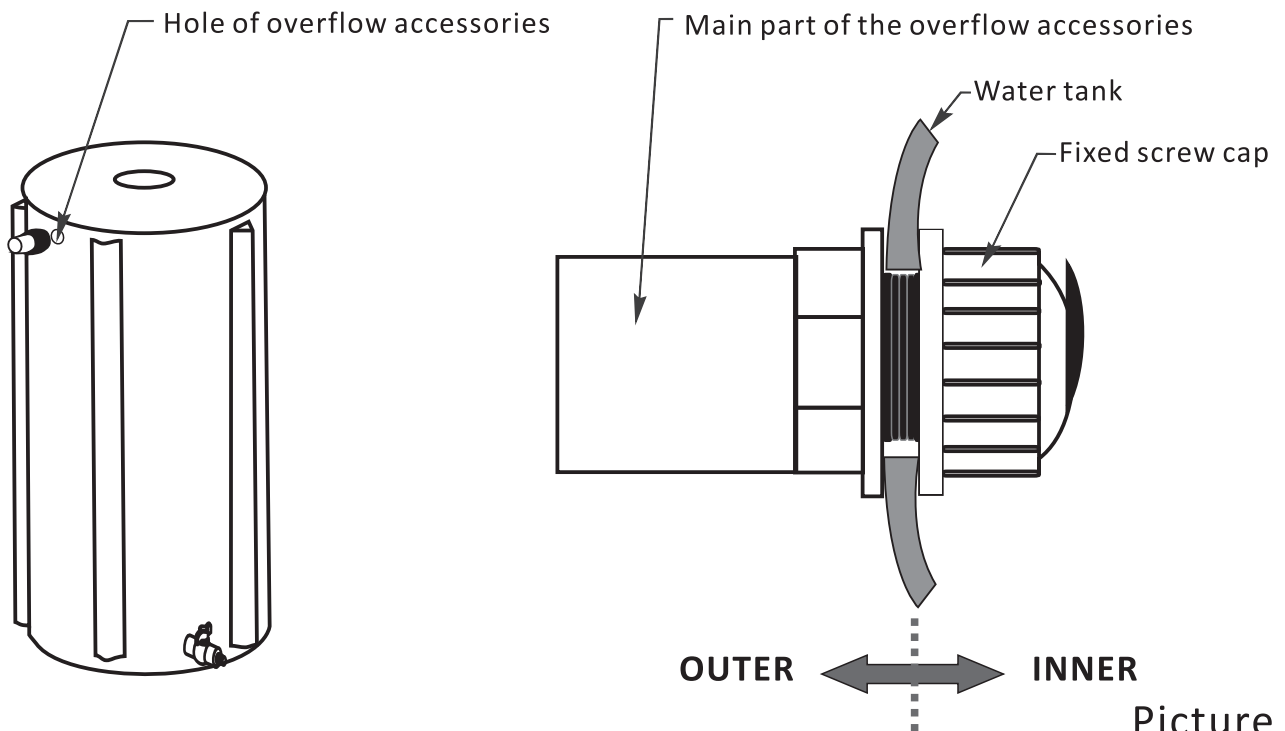

Picture 4

Fitting instruction

3. Thirdly, take out the supporting bar accessories from the packing box, Then insert the 5pcs supporting bar into the 5 corresponding holes of the water tank(Plastic stepping stone in the bottom face the earth). You can use it after installation.

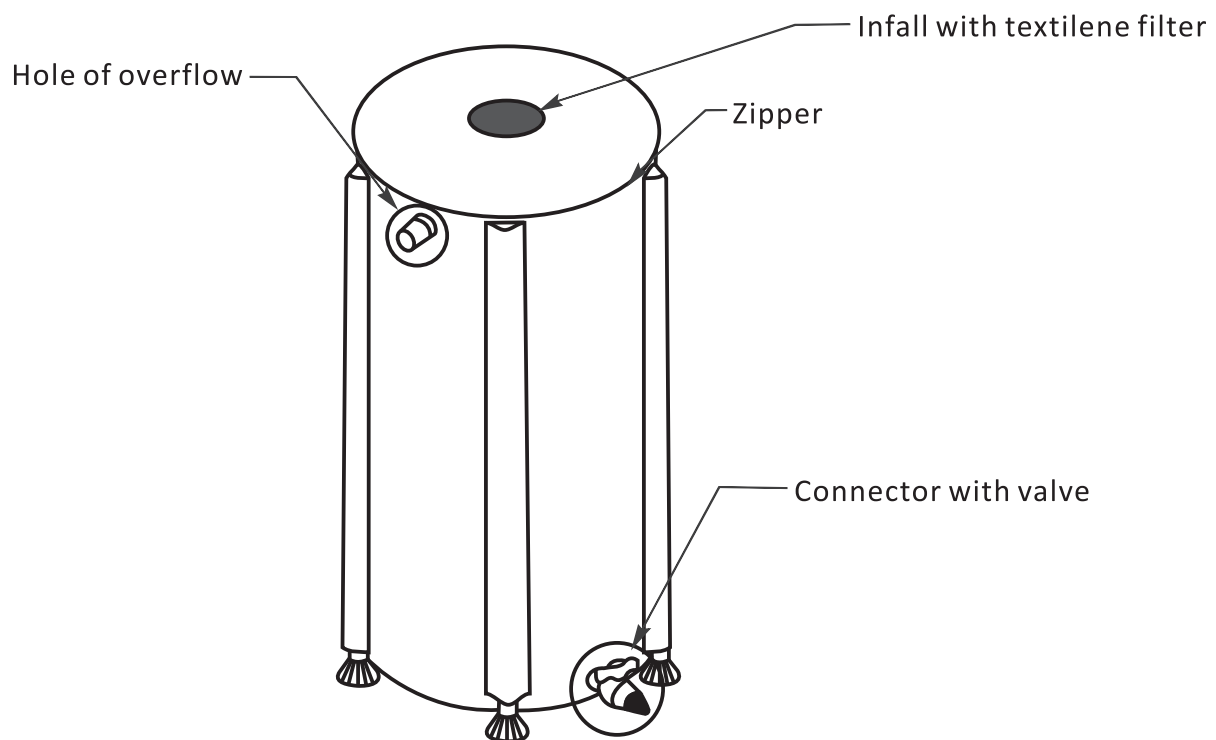
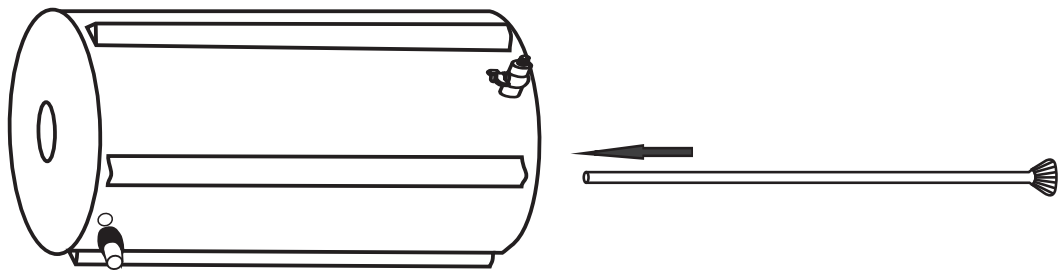

Operation instruction

1. After the installing of the product, which would be used directly according to the situation. The in-fall with textilene filtration net on the top can filter the impurities in the water efficiently, which can reduce the difficulties of the clearance in the inner side of water tank.

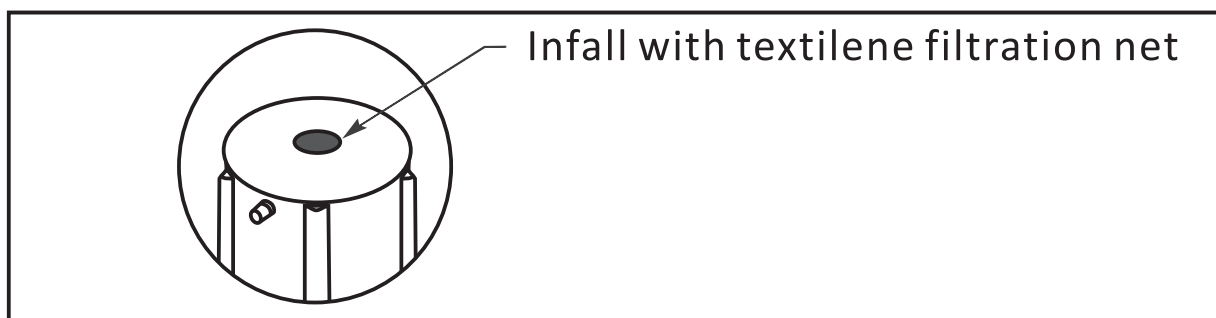

2. After undrawing the zipper on the top, it will be possible to open the whole top part of the water, which could be more convenient for us to store rainwater and fetch water, and the overflow part on the top can overflow the redundant water automatically when the water is full enough.

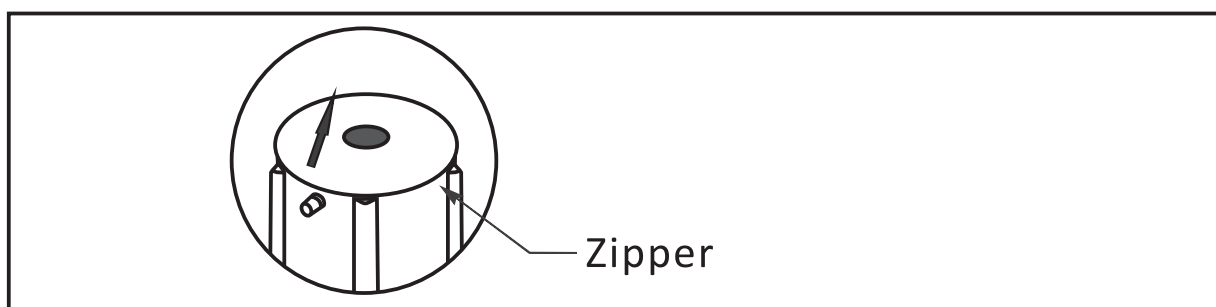

3. The outlet connector with valve can be connected with variety kinds of garden tools to expand the range of the usage better.

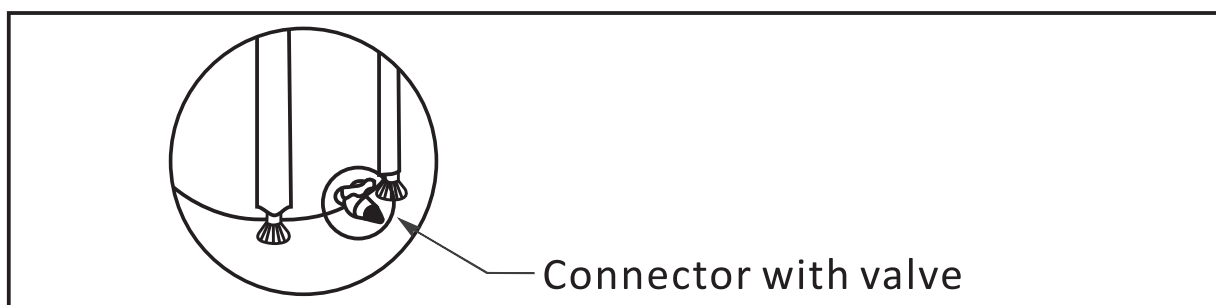

ATTENTIONS:

1. When using water tank, please install it according to the instruction and avoid collision bucket surface by sharp objects.
2. In order to improve product quality, we may have to change some partial structure and appearance of the product without inform of you, hope to get your understanding.
3. In order to ensure the lifetime of the product, please clean it after using each time.
4. Please collapse and install the product by instructions in order to avoid damage.
5. Please use brush or other similar cleaning tools to clean water bag.



Imported by: BUILDER SAS

32 rue Aristide Berges - Z.I. du Casque - 31270 Cugnaux - France.